

## Notification Appliance Mounting Accessories

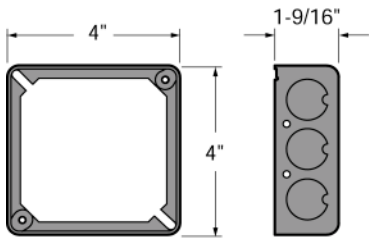

**3011B-0(\*)**  
Extension Ring

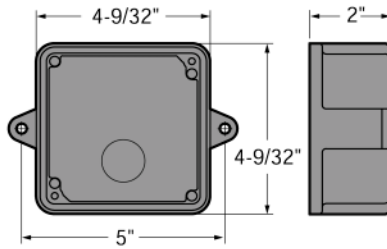

**3014/3015B-0(\*)**  
Weatherproof Box

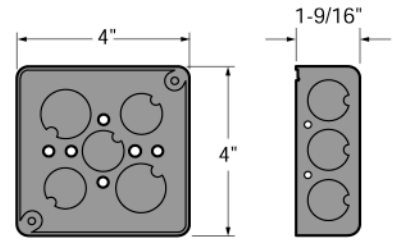

**3017B-0(\*)**  
Surface Box

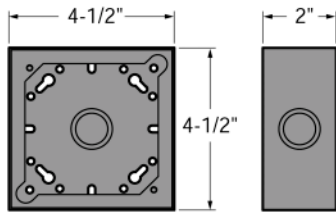

**3046B-0(\*)**  
Surface Box

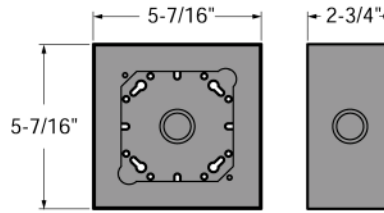

**3047B-0(\*)**  
Surface Box

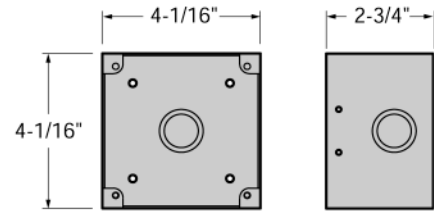

**3048B**  
Flush Box

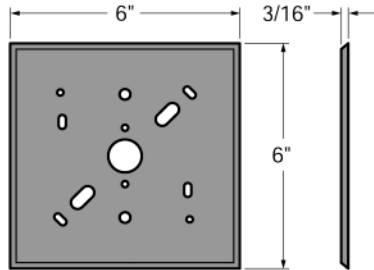

**3019B-0(\*)**  
Concealed Conduit Plate

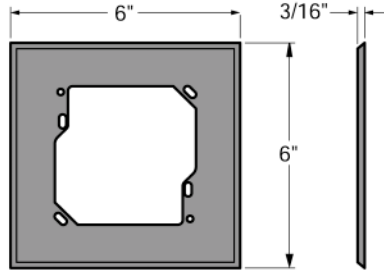

**3018B-0(\*)**  
Semi-Flush Plate

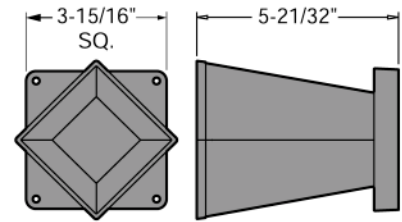

**5001B-0(\*)**  
Single Projector

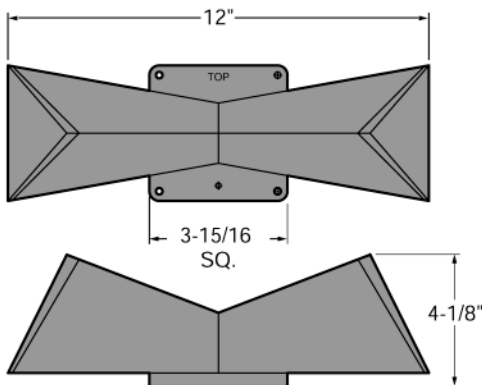

**5002B-0(\*)**  
Double Projector

**Notes:**

1. 3046 has (3) combination 1/2" and 3/4" knockouts (both sides and back).
2. 3047 and 3048 have (5) combination 1/2" and 3/4" knockouts (top, bottom, sides and back).
3. Device mounting holes on 3046, 3047 and 3048 are #8-32 tapped.

## Ordering Information

### Mounting & Replacement Accessories

Model	Description	Part No.
3011B-0-14	Extension Ring red	500-694493FA
3014B-0-14	Weatherproof Box - 1/2" Conduit red	500-694494FA
3014B-0-15	Weatherproof Box - 1/2" Conduit gray	500-648486FA
3014B-0-21	Weatherproof Box - 1/2" Conduit white	500-695773FA
3015B-0-14	Weatherproof Box - 3/4" Conduit red	500-694495FA
3015B-0-15	Weatherproof Box - 3/4" Conduit gray	500-648487FA
3015B-0-21	Weatherproof Box - 3/4" Conduit white	500-695774FA
3017B-0-14	Surface or Flush Box red	500-694496FA
3017B-0-15	Surface or Flush Box gray	500-648488FA
3017B-0-21	Surface or Flush Box white	500-695775FA
3018B-0-14	Semi-Flush Plate red	500-694497FA
3018B-0-15	Semi-Flush Plate gray	500-648489FA
3018B-0-21	Semi-Flush Plate white	500-695776FA
3019B-0-14	Concealed Conduit Plate red	500-694498FA
3019B-0-15	Concealed Conduit Plate gray	500-648490FA
3019B-0-21	Concealed Conduit Plate white	500-695777FA
5001B-0-14	Single Projector red	500-694499FA
5001B-0-15	Single Projector gray	500-648531FA
5001B-0-21	Single Projector white	500-648532FA
5002B-0-14	Double Projector white	500-694500FA
5002B-0-21	Double Projector white	500-648534FA
3046B-0-14	1.7 Inch Deep Surface Box red	500-695340FA
3046B-0-21	1.7 Inch Deep Surface Box white	500-695874FA
3047B-0-14	2.7 Inch Surface Box red	500-695341FA
3047B-0-21	2.7 Inch Surface Box white	500-695875FA
3048B	2.7 Inch Flush Box	500-695342FA



Siemens Building Technologies, Inc.  
8 Fernwood Road • Florham Park, NJ 07932  
Tel: (973) 593-2600 • Fax: (973) 593-6670  
Web: [www.faradayfirealarms.com](http://www.faradayfirealarms.com)

**WARNING** - The information contained in this document is intended only as a summary and is subject to change without notice. The devices described in this document have specific instruction sheets which cover various technical, limitation and liability information. Copies of these instruction sheets and the General Product Warning and Limitations Document, which also contains important information, are provided with the product and are available from the Manufacturer. Information contained in these documents should be consulted before specifying or using the product. For further information or assistance concerning particular problems contact the Manufacturer.